

Methods

Overview

- Class/Library/**static** vs. Message/non-**static**
- **return** and **void**
- Parameters and arguments

Dot and Parenthesis

- `x.y` means “the `y` inside `x`”
 - Similar to: `'s`
- `System.out.println` means “The `println` inside the `out` that is inside `System`”
- `x()` means “`x` is a method and I want to run it”

What is a **class**?

- A **class** can be (any mix of) 3 things:
 - A program
 - If and only if it has “**public static void** main(String[])”
 - A library of methods and constants
 - Examples: Math, JOptionPane
 - A description of a kind of object
 - ... We'll get into this in several weeks
 - Examples: Scanner, Random

static and non-static

- Consider `x.y()`
- If `x` is a **class**, `y` must be **static**
- If `x` is an Object, `y` should not be **static**

- `Math.cos()`: **static** because `Math` is a **class**
- `keyboard.nextInt()`: non-**static** because `keyboard` is an object (in particular, a `Scanner`).

Method Definition and Invocation

- A method is a named piece of code
- Defining a method = writing a how-to
- Invoking a method = following that how-to

- Pressing “run” just invokes main()

Parameters and Arguments

- A formal parameter is what a method writer assumes an invoker will bring to the table
- An actual argument is the thing the method invoker brings
- ... people are sloppy with these names ...

Parameters and Arguments

- How to fry **an egg**
 - Crack **the egg** into a pan
 - Add heat
- Parameters: what I call things I assume will exist when defining a method
- Fry **this ostrich egg**
- Fry **this chicken egg**
- Arguments: the values I use for the parameters when invoking a method

Parameters and Arguments

```
public class Example {  
    public static void f(int x) {  
        System.out.println(x + 2);  
    }  
}
```

```
public class ExampleUser {  
    public static void main( String[] args ) {  
        Example.f(3);  
        int y = 17;  
        Example.f(y - 2);  
    }  
}
```

Return

- When I ask you “what’s `sqrt(4)`,” you **return** “2” to me
- **return** is how methods give back values
- **return** is also a way to halt a method

Carbon Dating

- Archeologists can date artifacts by the relative concentration of carbon-14 in a sample compared to concentration in the air
- The formula is
$$\text{age} = \ln(\text{relative concentration}) \times -8260$$

```
public class Dater {  
    public static void main( String[] args ) {  
        int x = Dater.carbonDate( 0.05 );  
        System.out.println( "0.05 means " + x + " years old" );  
        System.out.println( "0.10 means "  
            + Dater.carbonDate( 0.10 ) + " years old" );  
    }  
  
    public static int carbonDate( double concentration ) {  
        double age = Math.log( concentration ) * -8260;  
        return (int)(age);  
    }  
}
```

Run invokes method main

```
public class Dater {  
    public static void main( String[] args ) {  
        int x = Dater.carbonDate( 0.05 );  
        System.out.println( "0.05 means " + x + " years old" );  
        System.out.println( "0.10 means "  
            + Dater.carbonDate( 0.10 ) + " years old" );  
    }  
  
    public static int carbonDate( double concentration ) {  
        double age = Math.log( concentration ) * -8260;  
        return (int)(age);  
    }  
}
```

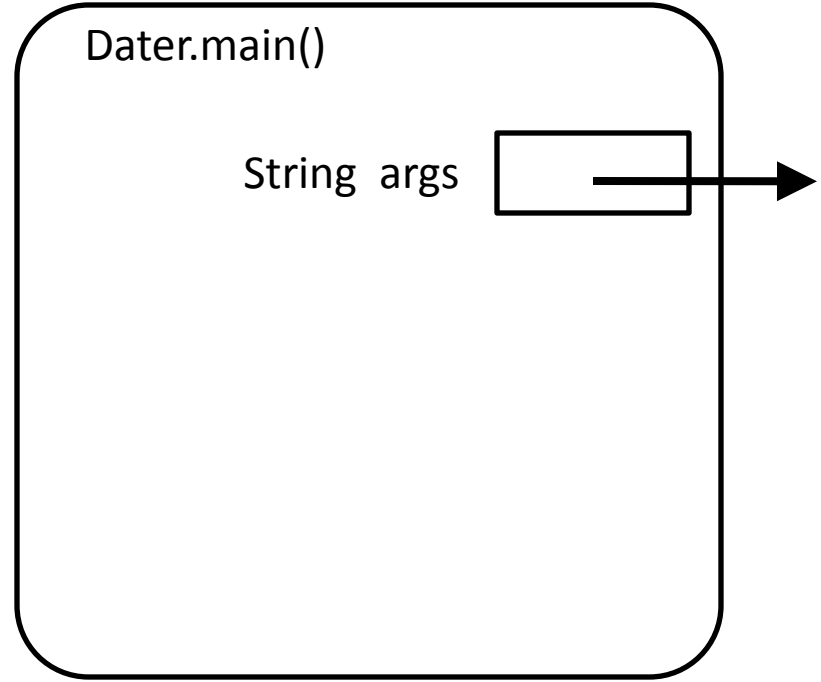

Create a variable x in main

```
public class Dater {  
    public static void main( String[] args ) {  
        int x = Dater.carbonDate( 0.05 );  
        System.out.println( "0.05 means " + x + " years old" );  
        System.out.println( "0.10 means "  
            + Dater.carbonDate( 0.10 ) + " years old" );  
    }  
  
    public static int carbonDate( double concentration ) {  
        double age = Math.log( concentration ) * -8260;  
        return (int)(age);  
    }  
}
```

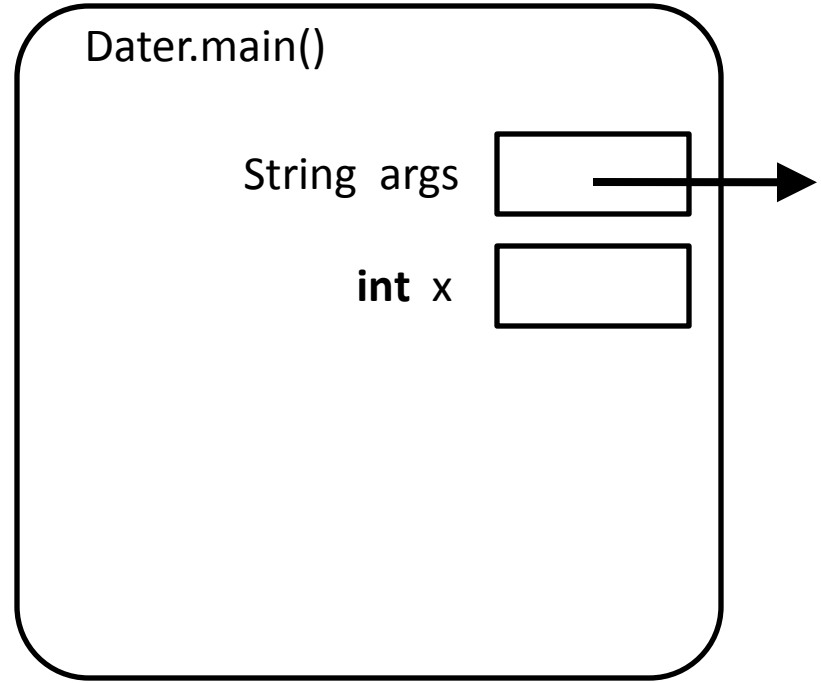

Invoke carbonDate with argument 0.05

```
public class Dater {  
    public static void main( String[] args ) {  
        int x = Dater.carbonDate( 0.05 );  
        System.out.println( "0.05 means " + x + " years old" );  
        System.out.println( "0.10 means "  
            + Dater.carbonDate( 0.10 ) + " years old" );  
    }  
  
    public static int carbonDate( double concentration ) {  
        double age = Math.log( concentration ) * -8260;  
        return (int)(age);  
    }  
}
```

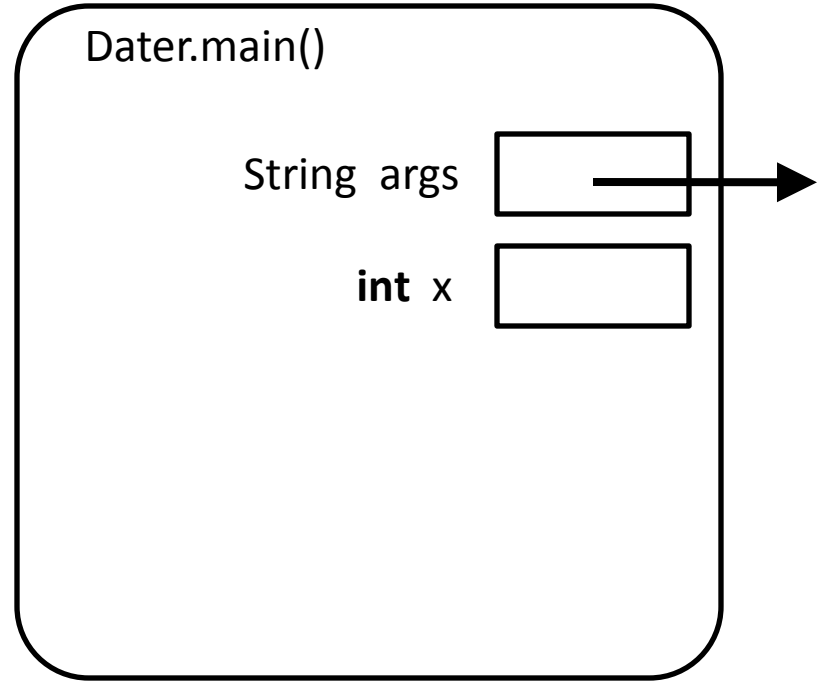

Invoke carbonDate with argument 0.05

```
public class Dater {  
    public static void main( String[] args ) {  
        int x = Dater.carbonDate( 0.05 );  
        System.out.println( "0.05 means " + x + " years old" );  
        System.out.println( "0.10 means "  
            + Dater.carbonDate( 0.10 ) + " years old" );  
    }  
  
    public static int carbonDate( double concentration ) {  
        double age = Math.log( concentration ) * -8260;  
        return (int)(age);  
    }  
}
```

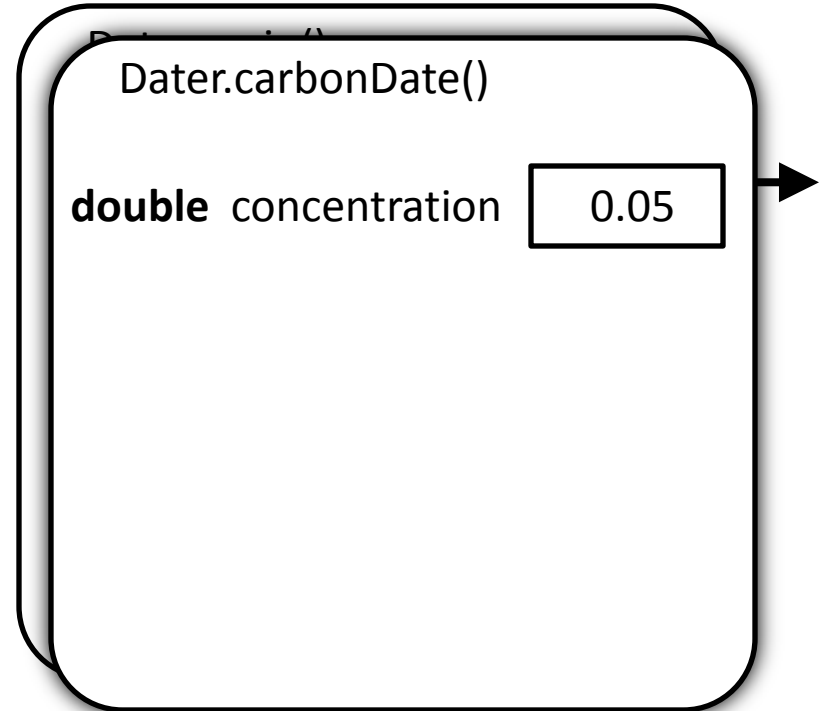

Create a variable age in carbonDate

```
public class Dater {  
    public static void main( String[] args ) {  
        int x = Dater.carbonDate( 0.05 );  
        System.out.println( "0.05 means " + x + " years old" );  
        System.out.println( "0.10 means "  
            + Dater.carbonDate( 0.10 ) + " years old" );  
    }  
  
    public static int carbonDate( double concentration ) {  
        double age = Math.log( concentration ) * -8260;  
        return (int)(age);  
    }  
}
```

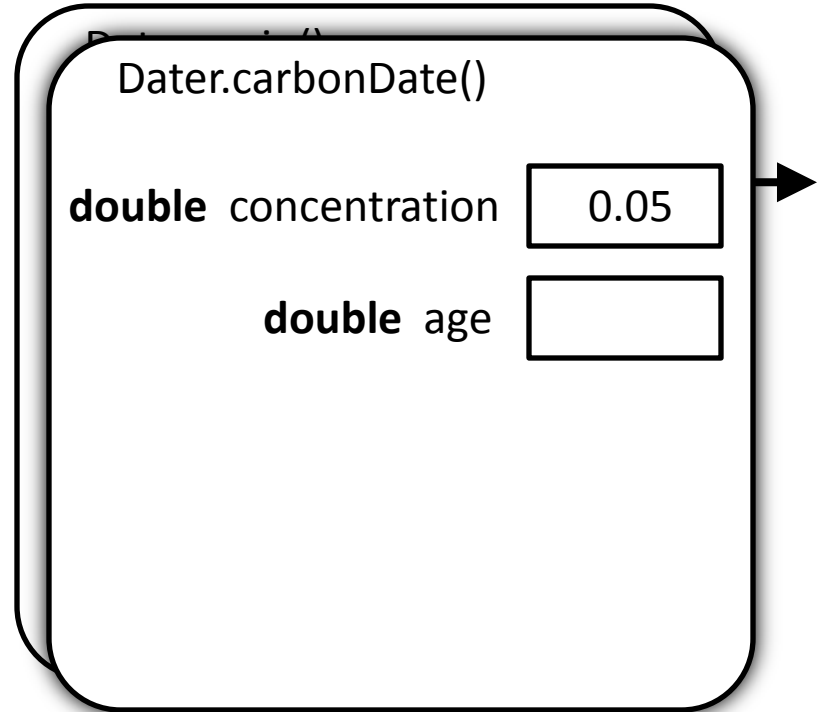

Invoke Math's log method with argument 0.05

```
public class Dater {  
    public static void main( String[] args ) {  
        int x = Dater.carbonDate( 0.05 );  
        System.out.println( "0.05 means " + x + " years old" );  
        System.out.println( "0.10 means "  
            + Dater.carbonDate( 0.10 ) + " years old" );  
    }  
  
    public static int carbonDate( double concentration ) {  
        double age = Math.log( concentration ) * -8260;  
        return (int)(age);  
    }  
}
```

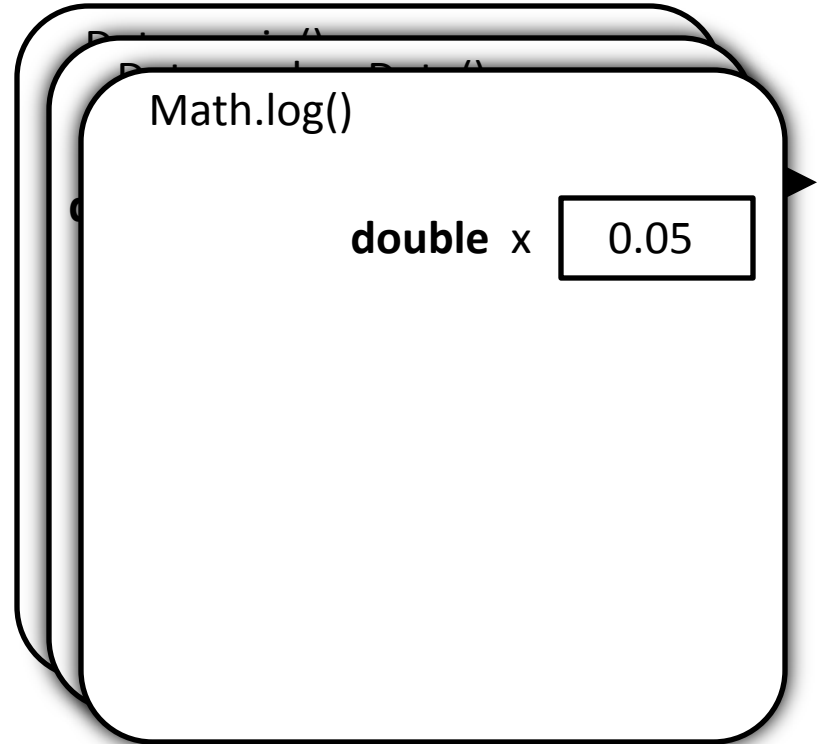

Invoke Math's log method with argument 0.05

```
public class Dater {  
    public static void main( String[] args ) {  
        int x = Dater.carbonDate( 0.05 );  
        System.out.println( "0.05 means " + x + " years old" );  
        System.out.println( "0.10 means "  
            + Dater.carbonDate( 0.10 ) + " years old" );  
    }  
  
    public static int carbonDate( double concentration ) {  
        double age = Math.log( concentration ) * -8260;  
        return (int)(age);  
    }  
}
```



Math.log()

-2.99573...

Invoke Math's log method with argument 0.05

```
public class Dater {  
    public static void main( String[] args ) {  
        int x = Dater.carbonDate( 0.05 );  
        System.out.println( "0.05 means " + x + " years old" );  
        System.out.println( "0.10 means "  
            + Dater.carbonDate( 0.10 ) + " years old" );  
    }  
  
    public static int carbonDate( double concentration )  
    {  
        double age = Math.log( concentration ) * -8260;  
        return (int)(age);  
    }  
}
```

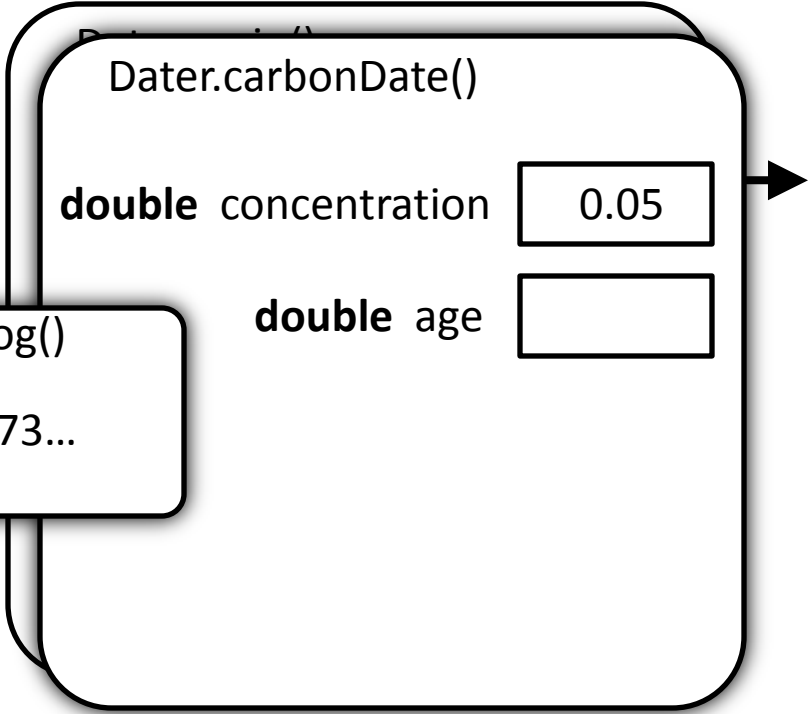

Invoke Math's log method with argument 0.05

```
public class Dater {  
    public static void main( String[] args ) {  
        int x = Dater.carbonDate( 0.05 );  
        System.out.println( "0.05 means " + x + " years old" );  
        System.out.println( "0.10 means "  
            + Dater.carbonDate( 0.10 ) + " years old" );  
    }  
  
    public static int carbonDate( double concentration ) {  
        double age =  * -8260;  
        return (int)(age);  
    }  
}
```

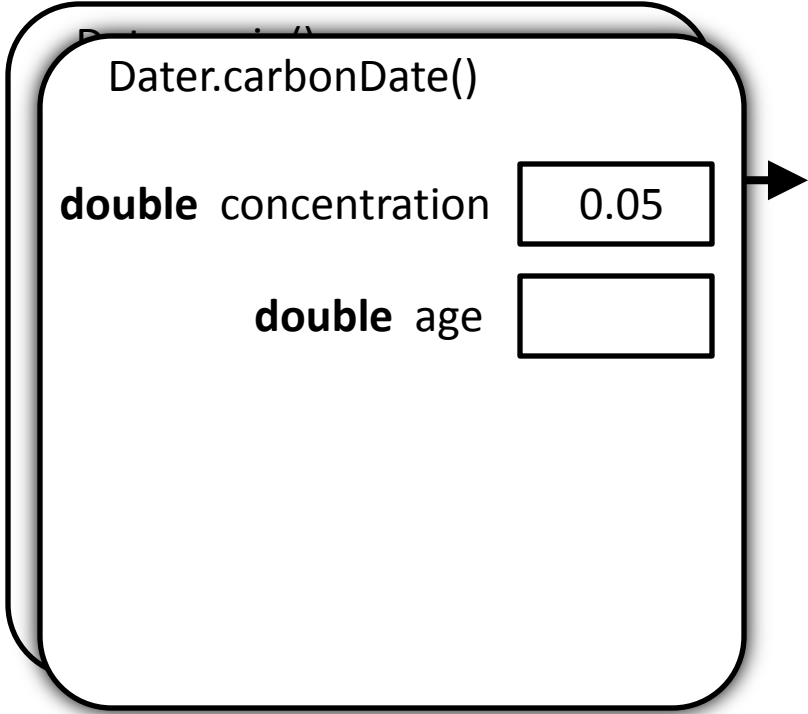

Compute the value (24744.748...)
and store it in age

```
public class Dater {  
    public static void main( String[] args ) {  
        int x = Dater.carbonDate( 0.05 );  
        System.out.println( "0.05 means " + x + " years old" );  
        System.out.println( "0.10 means "  
            + Dater.carbonDate( 0.10 ) + " years old" );  
    }  
  
    public static int carbonDate( double concentration ) {  
        double age = -2.99573... * -8260;  
        return (int)(age);  
    }  
}
```

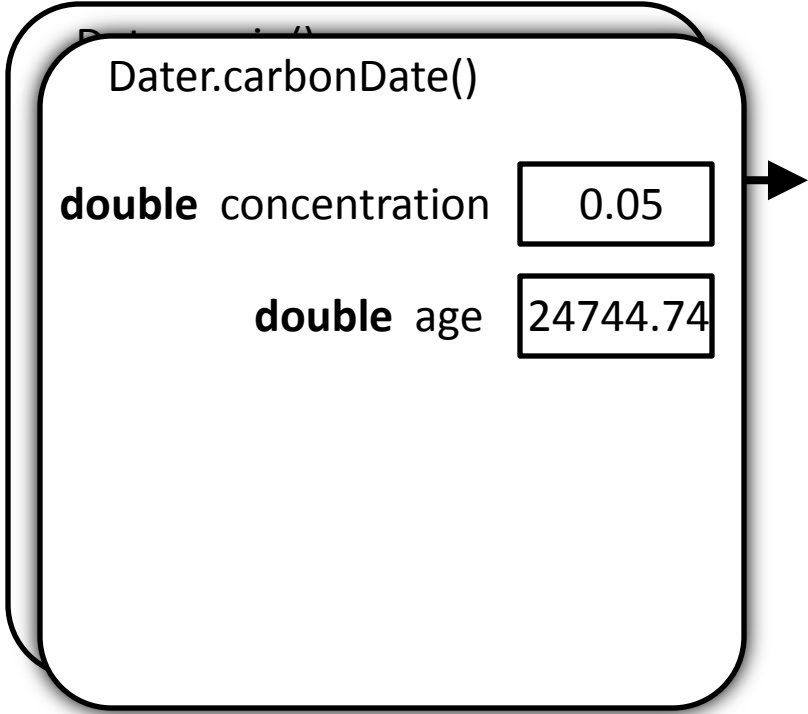

Compute the return value (24744)

```
public class Dater {  
    public static void main( String[] args ) {  
        int x = Dater.carbonDate( 0.05 );  
        System.out.println( "0.05 means " + x + " years old" );  
        System.out.println( "0.10 means "  
            + Dater.carbonDate( 0.10 ) + " years old" );  
    }  
  
    public static int carbonDate( double concentration ) {  
        double age = Math.log( concentration ) * -8260;  
        return (int)(age);  
    }  
}
```

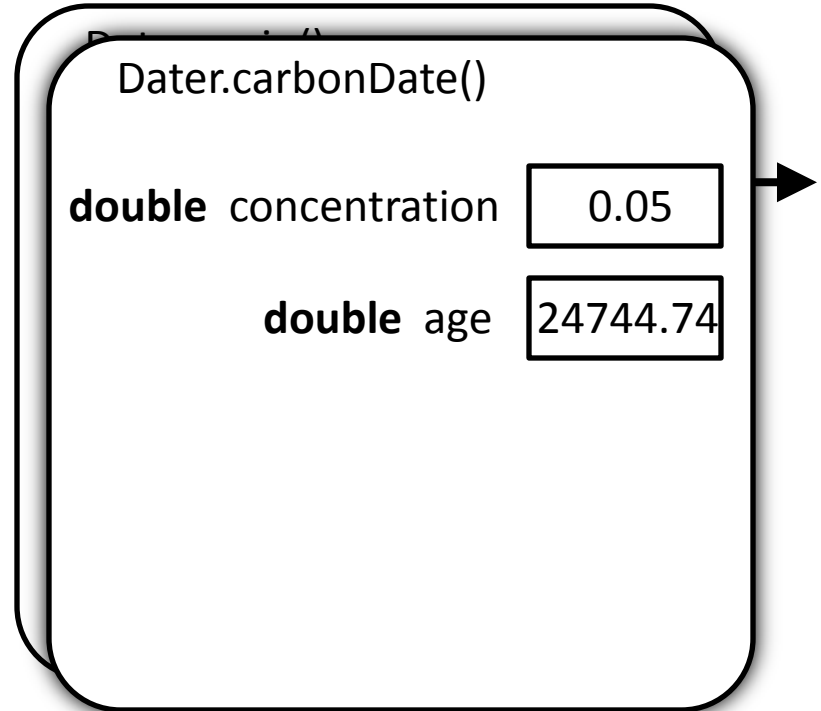

return and store the result

```
public class Dater {  
    public static void main( String[] args ) {  
        int x = Dater.carbonDate( 0.05 );  
        System.out.println( "0.05 means " + x + " years old" );  
        System.out.println( "0.10 means "  
            + Dater.carbonDate( 0.10 ) + " years old" );  
    }  
  
    public static int carbonDate( double concentration ) {  
        double age = Math.log( concentration ) * -8260;  
        return (int)(age);  
    }  
}
```

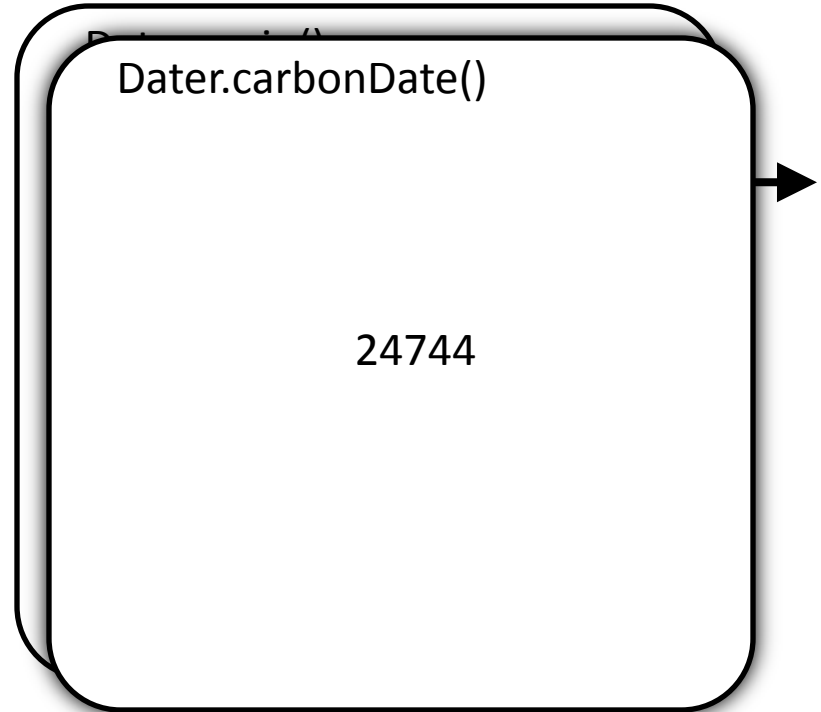

return and store the result

```
public class Dater {  
    public static void main( String[] args ) {  
        int x = Dater.carbonDate( 0.05 );  
        System.out.println( "0.05 means " + x + " years old" );  
        System.out.println( "0.10 means "  
            + Dater.carbonDate( 0.10 ) + " years old" );  
    }  
  
    public static int carbonDate( double concentration ) {  
        double age = Math.log( concentration ) * -8260;  
        return (int)(age);  
    }  
}
```

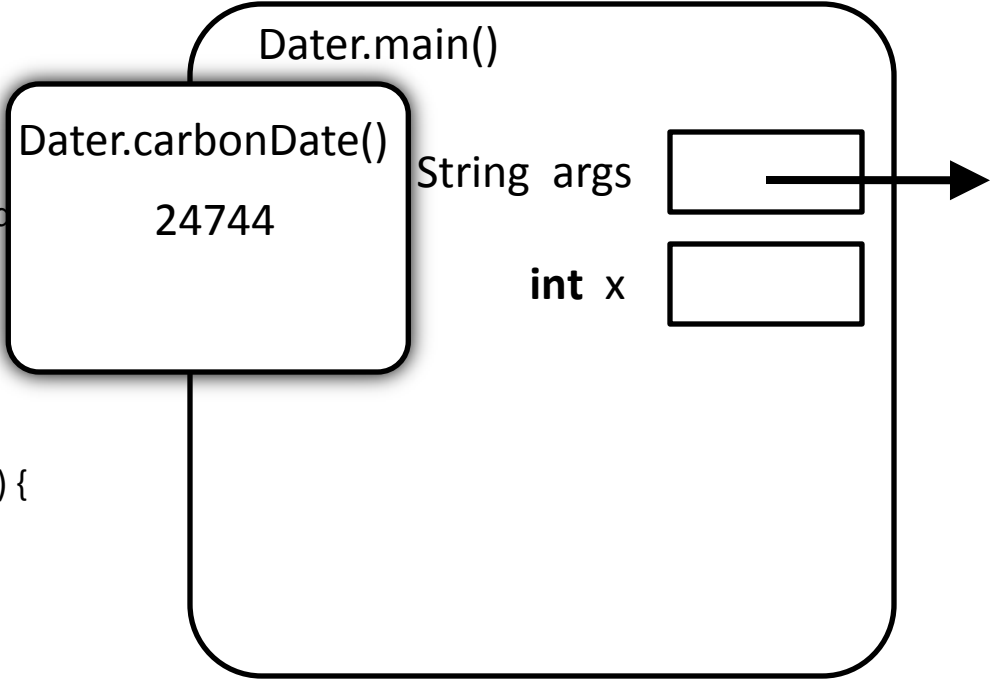

return and store the result

```
public class Dater {  
    public static void main( String[] args ) {  
        int x = 24744 ;  
        System.out.println( "0.05 means " + x + " years old" );  
        System.out.println( "0.10 means "  
            + Dater.carbonDate( 0.10 ) + " years old" );  
    }  
  
    public static int carbonDate( double concentration ) {  
        double age = Math.log( concentration ) * -8260;  
        return (int)(age);  
    }  
}
```

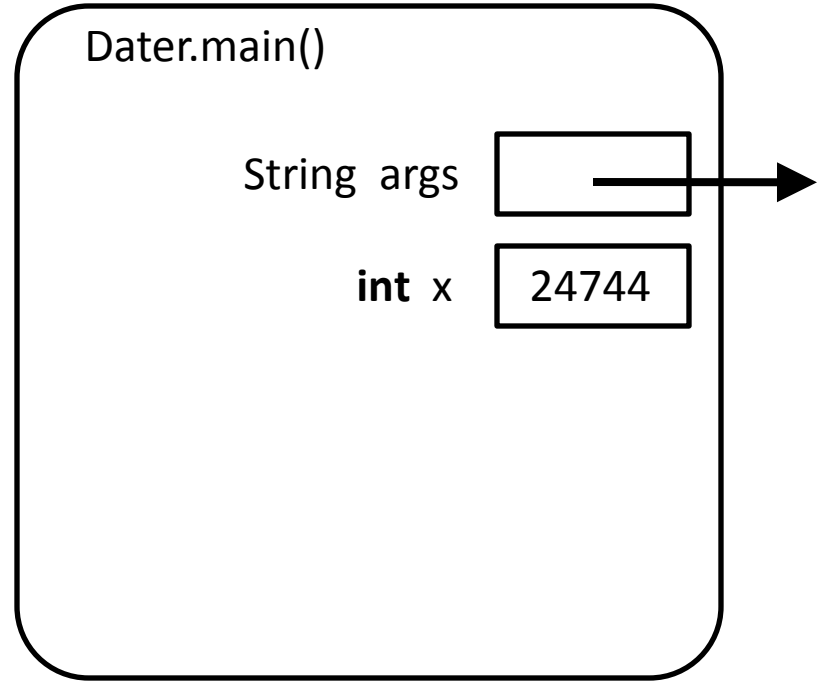

After returning, carbonDate's variables disappear

```
public class Dater {  
    public static void main( String[] args ) {  
        int x = Dater.carbonDate( 0.05 );  
        System.out.println( "0.05 means " + x + " years old" );  
        System.out.println( "0.10 means "  
            + Dater.carbonDate( 0.10 ) + " years old" );  
    }  
  
    public static int carbonDate( double concentration ) {  
        double age = Math.log( concentration ) * -8260;  
        return (int)(age);  
    }  
}
```

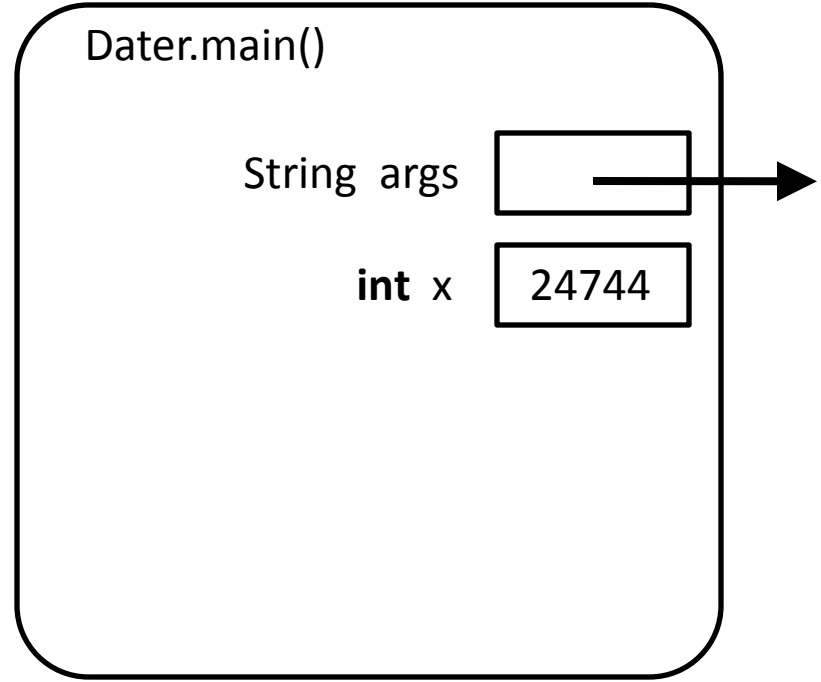

Compute the string to print:
"0.05 means 24744 years old"

```
public class Dater {  
    public static void main( String[] args ) {  
        int x = Dater.carbonDate( 0.05 );  
        System.out.println("0.05 means " + x + " years old");  
        System.out.println( "0.10 means "  
            + Dater.carbonDate( 0.10 ) + " years old" );  
    }  
  
    public static int carbonDate( double concentration ) {  
        double age = Math.log( concentration ) * -8260;  
        return (int)(age);  
    }  
}
```

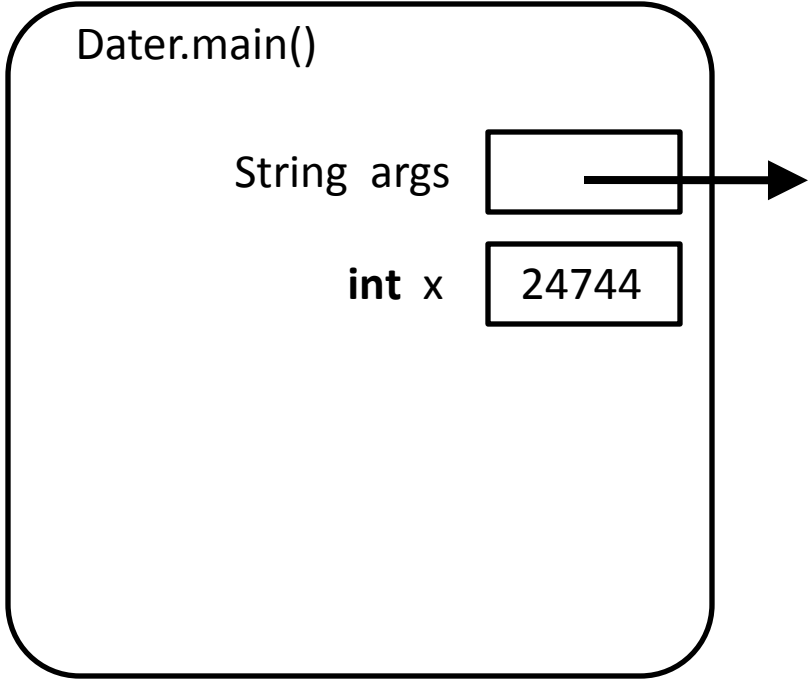

Invoke System.out's println method

```
public class Dater {  
    public static void main( String[] args ) {  
        int x = Dater.carbonDate( 0.05 );  
        System.out.println( "0.05 means " + x + " years old" );  
        System.out.println( "0.10 means "  
            + Dater.carbonDate( 0.10 ) + " years old" );  
    }  
  
    public static int carbonDate( double concentration ) {  
        double age = Math.log( concentration ) * -8260;  
        return (int)(age);  
    }  
}
```

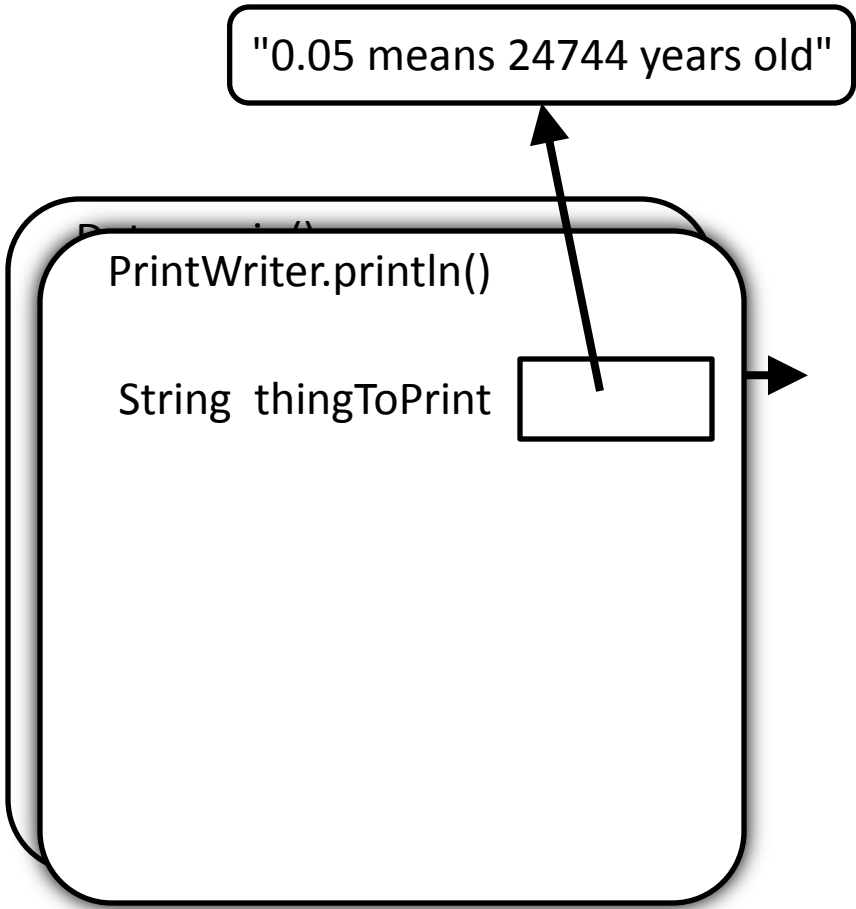

Invoke carbonDate with argument 0.10

```
public class Dater {  
    public static void main( String[] args ) {  
        int x = Dater.carbonDate( 0.05 );  
        System.out.println( "0.05 means " + x + " years old" );  
        System.out.println( "0.10 means "  
            + Dater.carbonDate( 0.10 ) + " years old" );  
    }  
  
    public static int carbonDate( double concentration ) {  
        double age = Math.log( concentration ) * -8260;  
        return (int)(age);  
    }  
}
```

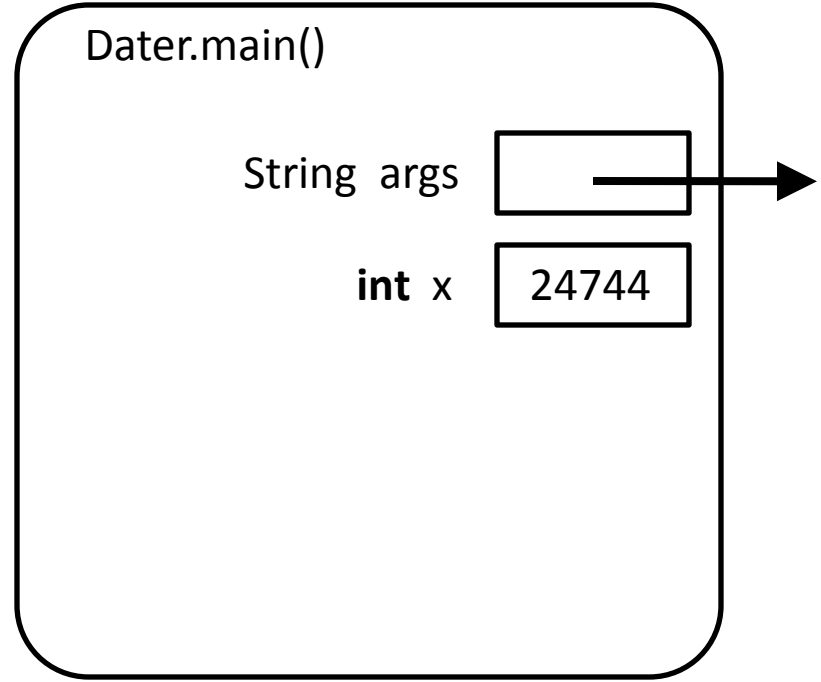

Invoke carbonDate with argument 0.10

```
public class Dater {  
    public static void main( String[] args ) {  
        int x = Dater.carbonDate( 0.05 );  
        System.out.println( "0.05 means " + x + " years old" );  
        System.out.println( "0.10 means "  
            + Dater.carbonDate( 0.10 ) + " years old" );  
    }  
  
    public static int carbonDate( double concentration ) {  
        double age = Math.log( concentration ) * -8260;  
        return (int)(age);  
    }  
}
```

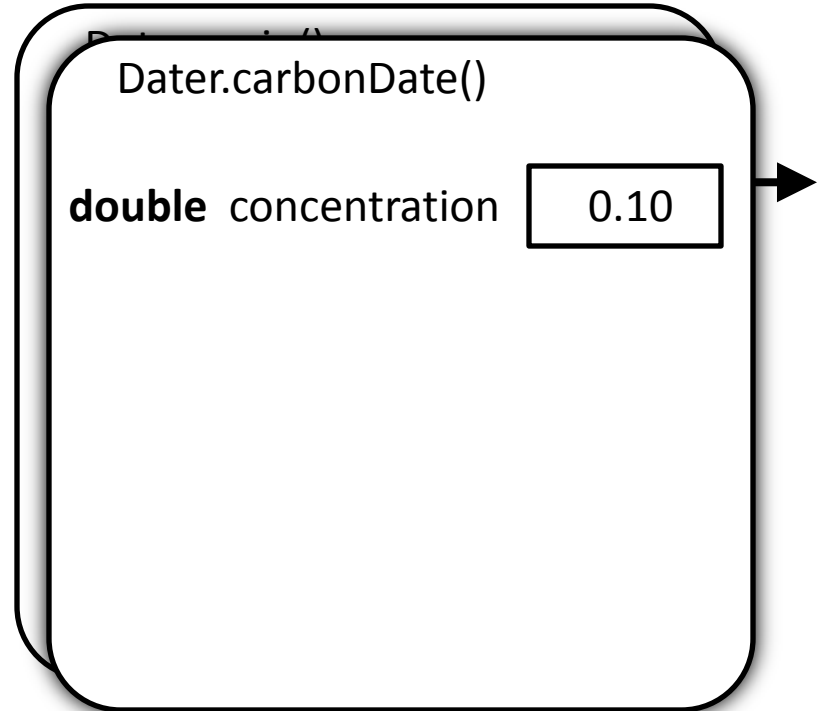

Create a variable age in carbonDate

```
public class Dater {  
    public static void main( String[] args ) {  
        int x = Dater.carbonDate( 0.05 );  
        System.out.println( "0.05 means " + x + " years old" );  
        System.out.println( "0.10 means "  
            + Dater.carbonDate( 0.10 ) + " years old" );  
    }  
  
    public static int carbonDate( double concentration ) {  
        double age = Math.log( concentration ) * -8260;  
        return (int)(age);  
    }  
}
```

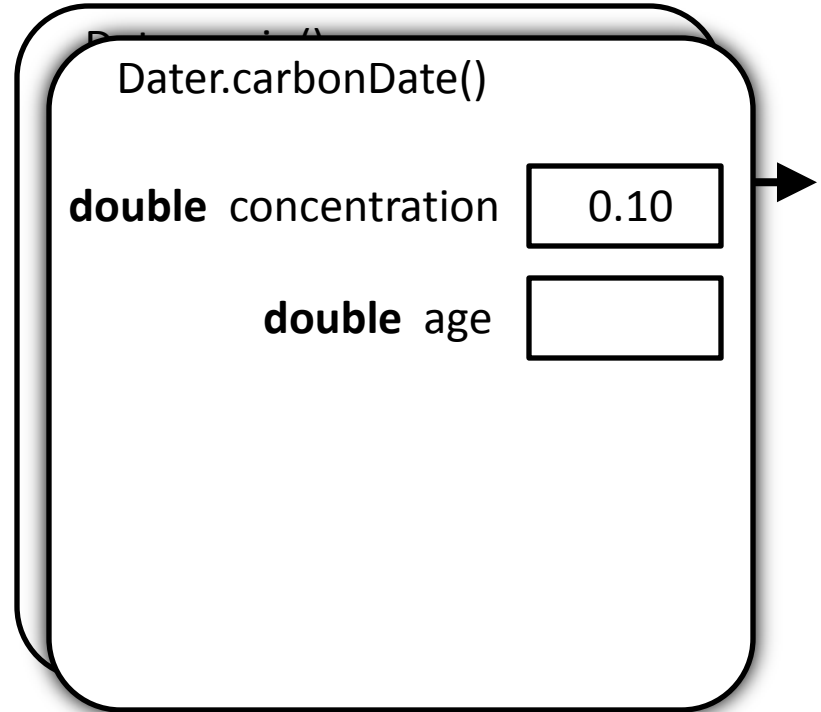

Invoke Math's log method with argument 0.10

```
public class Dater {  
    public static void main( String[] args ) {  
        int x = Dater.carbonDate( 0.05 );  
        System.out.println( "0.05 means " + x + " years old" );  
        System.out.println( "0.10 means "  
            + Dater.carbonDate( 0.10 ) + " years old" );  
    }  
  
    public static int carbonDate( double concentration ) {  
        double age = Math.log( concentration ) * -8260;  
        return (int)(age);  
    }  
}
```

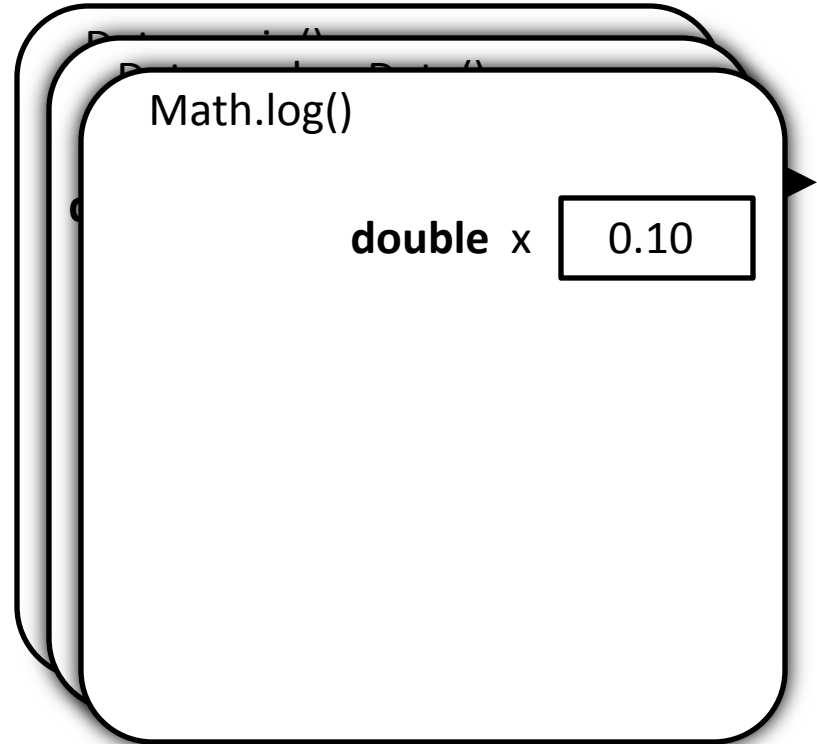

Invoke Math's log method with argument 0.10

```
public class Dater {  
    public static void main( String[] args ) {  
        int x = Dater.carbonDate( 0.05 );  
        System.out.println( "0.05 means " + x + " years old" );  
        System.out.println( "0.10 means "  
            + Dater.carbonDate( 0.10 ) + " years old" );  
    }  
  
    public static int carbonDate( double concentrati  
        double age = Math.log( concentration ) * -8260;  
        return (int)(age);  
    }  
}
```

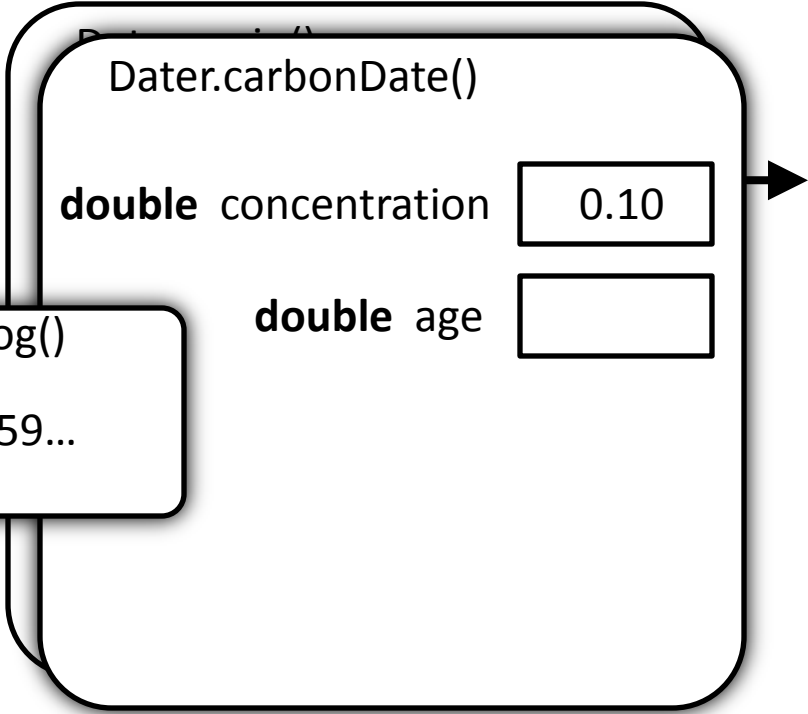

Invoke Math's log method with argument 0.10

```
public class Dater {  
    public static void main( String[] args ) {  
        int x = Dater.carbonDate( 0.05 );  
        System.out.println( "0.05 means " + x + " years old" );  
        System.out.println( "0.10 means "  
            + Dater.carbonDate( 0.10 ) + " years old" );  
    }  
  
    public static int carbonDate( double concentration ) {  
        double age =  * -8260;  
        return (int)(age);  
    }  
}
```

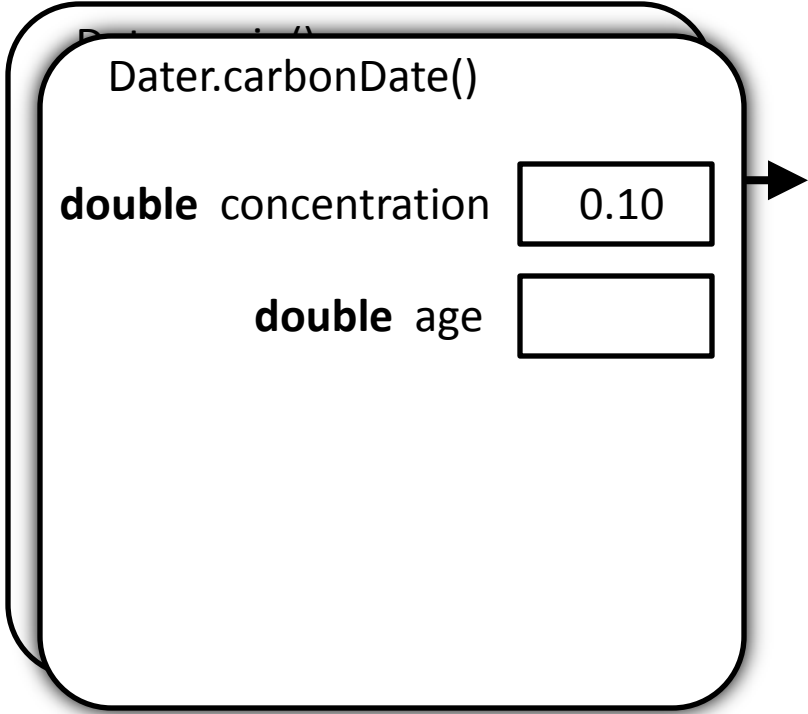

Compute the value (19019.352...)
and store it in age

```
public class Dater {  
    public static void main( String[] args ) {  
        int x = Dater.carbonDate( 0.05 );  
        System.out.println( "0.05 means " + x + " years old" );  
        System.out.println( "0.10 means "  
            + Dater.carbonDate( 0.10 ) + " years old" );  
    }  
  
    public static int carbonDate( double concentration ) {  
        double age = -2.30259... * -8260;  
        return (int)(age);  
    }  
}
```

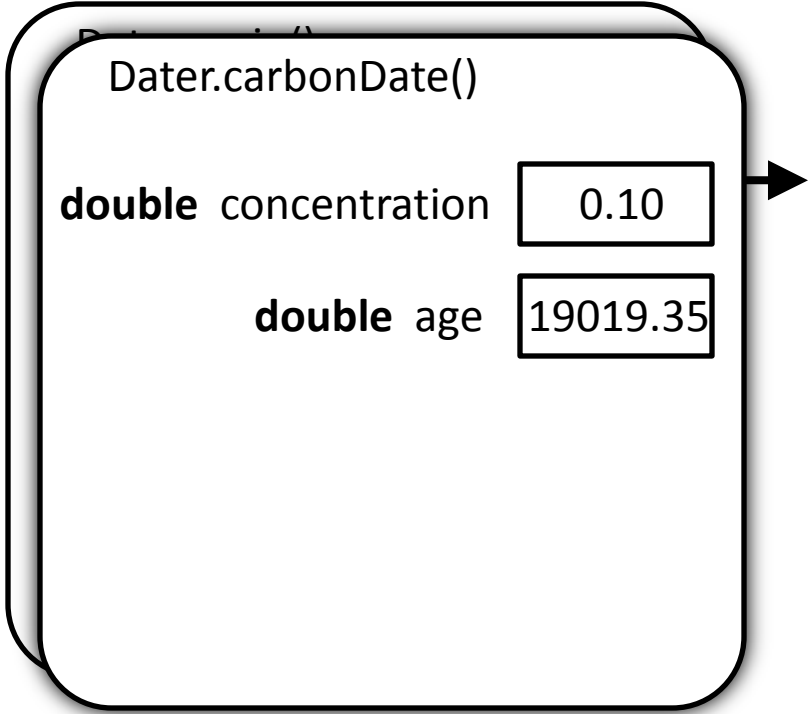

Compute the return value (19019)

```
public class Dater {  
    public static void main( String[] args ) {  
        int x = Dater.carbonDate( 0.05 );  
        System.out.println( "0.05 means " + x + " years old" );  
        System.out.println( "0.10 means "  
            + Dater.carbonDate( 0.10 ) + " years old" );  
    }  
  
    public static int carbonDate( double concentration ) {  
        double age = Math.log( concentration ) * -8260;  
        return (int)(age);  
    }  
}
```

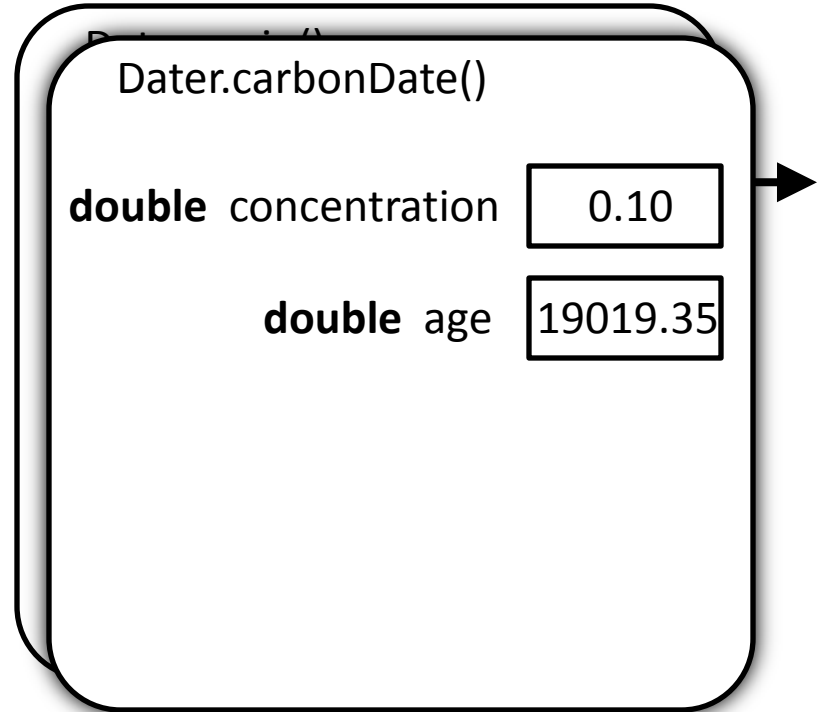

return and use the result

```
public class Dater {  
    public static void main( String[] args ) {  
        int x = Dater.carbonDate( 0.05 );  
        System.out.println( "0.05 means " + x + " years old" );  
        System.out.println( "0.10 means "  
            + Dater.carbonDate( 0.10 ) + " years old" );  
    }  
  
    public static int carbonDate( double concentration ) {  
        double age = Math.log( concentration ) * -8260;  
        return (int)(age);  
    }  
}
```

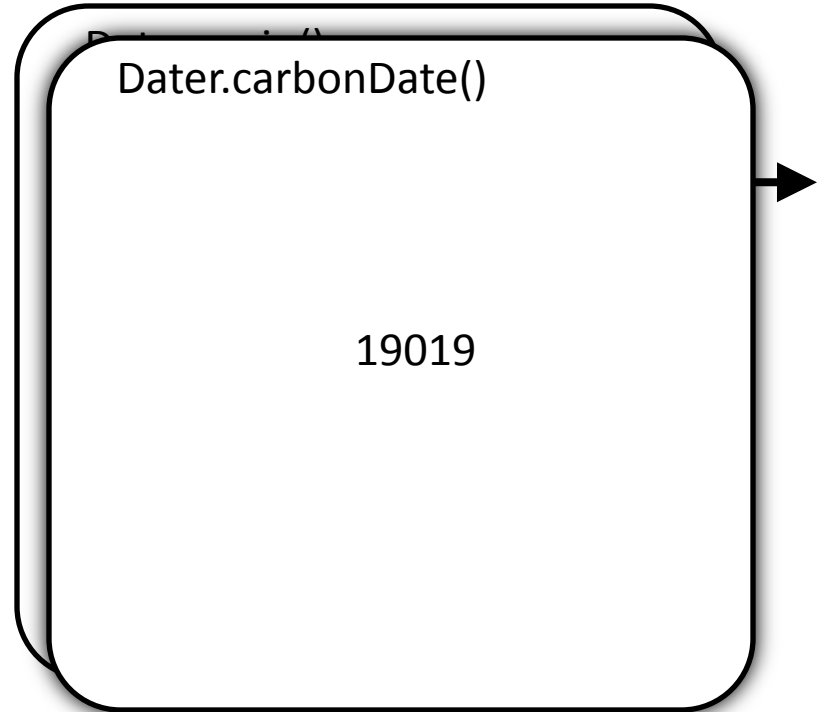

return and use the result

```
public class Dater {  
    public static void main( String[] args ) {  
        int x = Dater.carbonDate( 0.05 );  
        System.out.println( "0.05 means " + x + " years  
        System.out.println( "0.10 means "  
            + Dater.carbonDate( 0.10 ) + " years old" );  
    }  
  
    public static int carbonDate( double concentration ) {  
        double age = Math.log( concentration ) * -8260;  
        return (int)(age);  
    }  
}
```

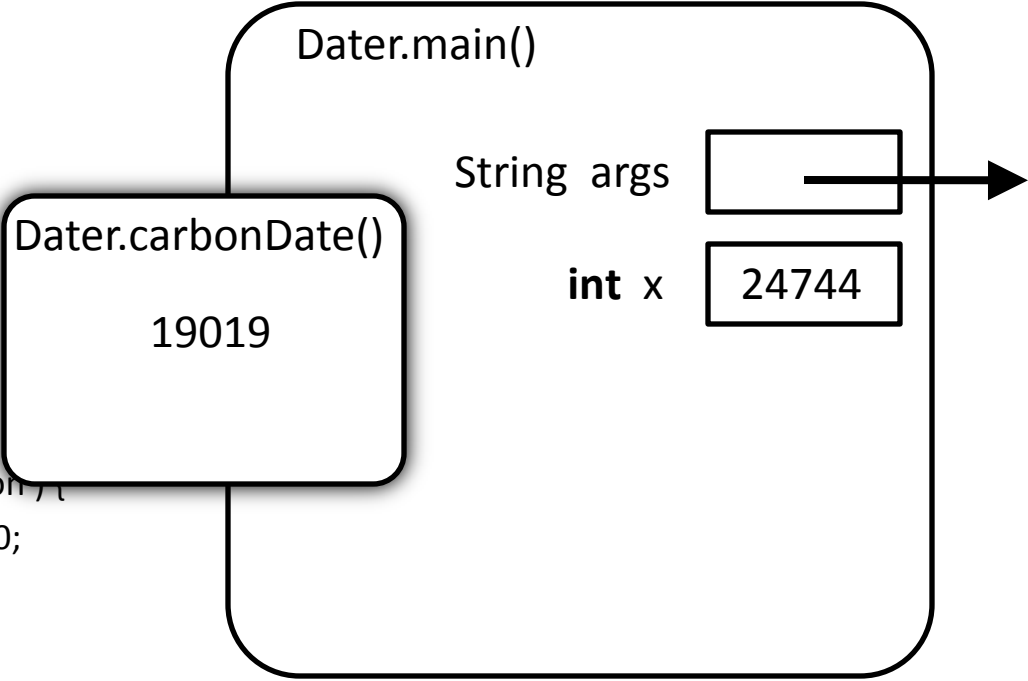

return and use the result

```
public class Dater {  
    public static void main( String[] args ) {  
        int x = Dater.carbonDate( 0.05 );  
        System.out.println( "0.05 means " + x + " years old" );  
        System.out.println( "0.10 means "  
            + 19019 + " years old" );  
    }  
  
    public static int carbonDate( double concentration ) {  
        double age = Math.log( concentration ) * -8260;  
        return (int)(age);  
    }  
}
```

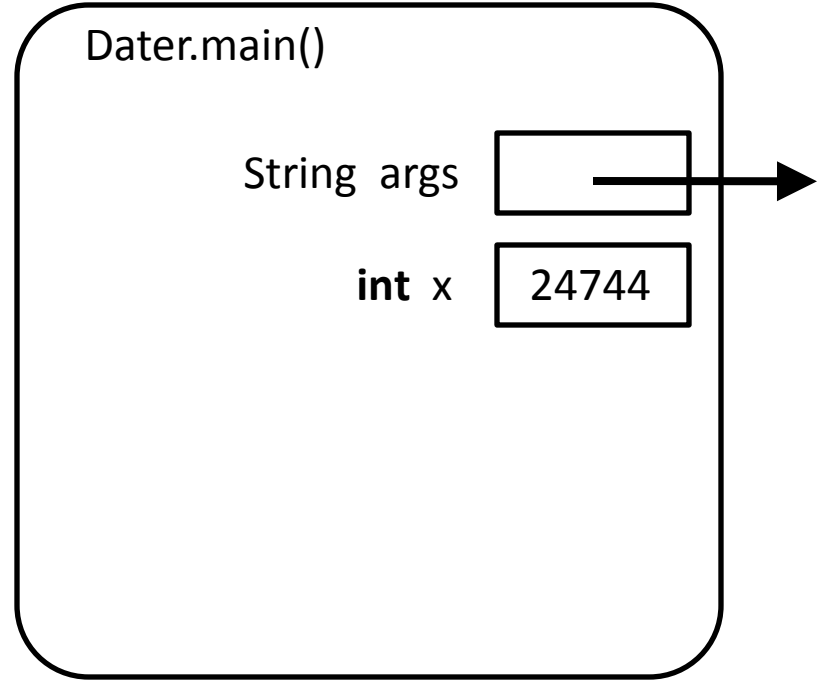

After returning, carbonDate's variables disappear

```
public class Dater {  
    public static void main( String[] args ) {  
        int x = Dater.carbonDate( 0.05 );  
        System.out.println( "0.05 means " + x + " years old" );  
        System.out.println( "0.10 means "  
            + 19019 + " years old" );  
    }  
  
    public static int carbonDate( double concentration ) {  
        double age = Math.log( concentration ) * -8260;  
        return (int)(age);  
    }  
}
```

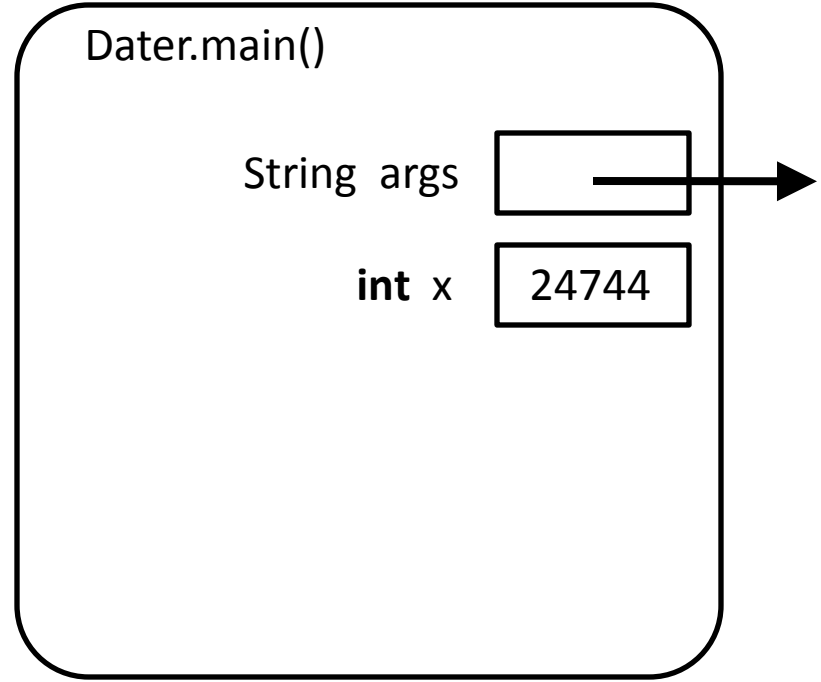

Compute the string to print:
"0.10 means 19019 years old"

```
public class Dater {  
    public static void main( String[] args ) {  
        int x = Dater.carbonDate( 0.05 );  
        System.out.println( "0.05 means " + x + " years old" );  
        System.out.println( "0.10 means "  
        + 19019 + " years old" );  
    }  
  
    public static int carbonDate( double concentration ) {  
        double age = Math.log( concentration ) * -8260;  
        return (int)(age);  
    }  
}
```

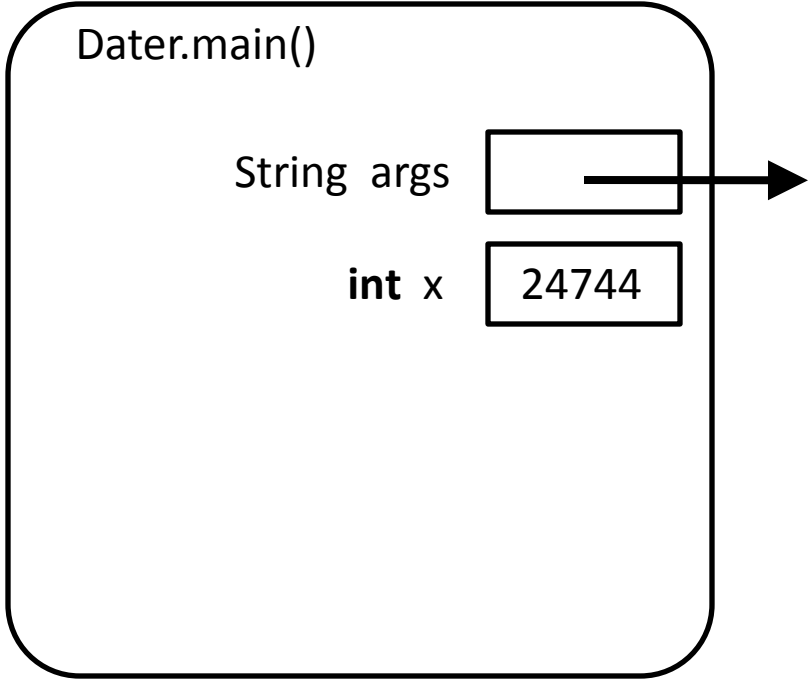

Invoke System.out's println method

```
public class Dater {  
    public static void main( String[] args ) {  
        int x = Dater.carbonDate( 0.05 );  
        System.out.println( "0.05 means " + x + " years old" );  
        System.out.println( "0.10 means "  
            + "19019" + " years old" );  
    }  
  
    public static int carbonDate( double concentration ) {  
        double age = Math.log( concentration ) * -8260;  
        return (int)(age);  
    }  
}
```

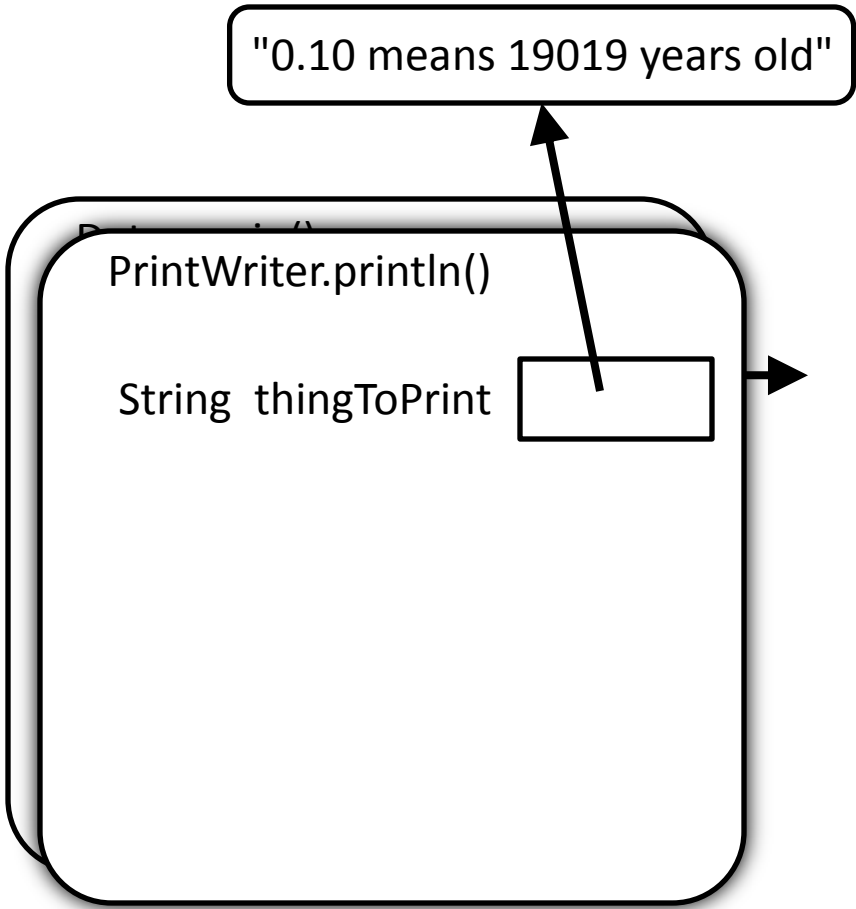

After main ends, its variables disappear

```
public class Dater {  
    public static void main( String[] args ) {  
        int x = Dater.carbonDate( 0.05 );  
        System.out.println( "0.05 means " + x + " years old" );  
        System.out.println( "0.10 means "  
            + Dater.carbonDate( 0.10 ) + " years old" );  
    }  
  
    public static int carbonDate( double concentration ) {  
        double age = Math.log( concentration ) * -8260;  
        return (int)(age);  
    }  
}
```